

TOSHIBA

SMMSu

SUPER MODULAR MULTI SYSTEM

The ultimate VRF system

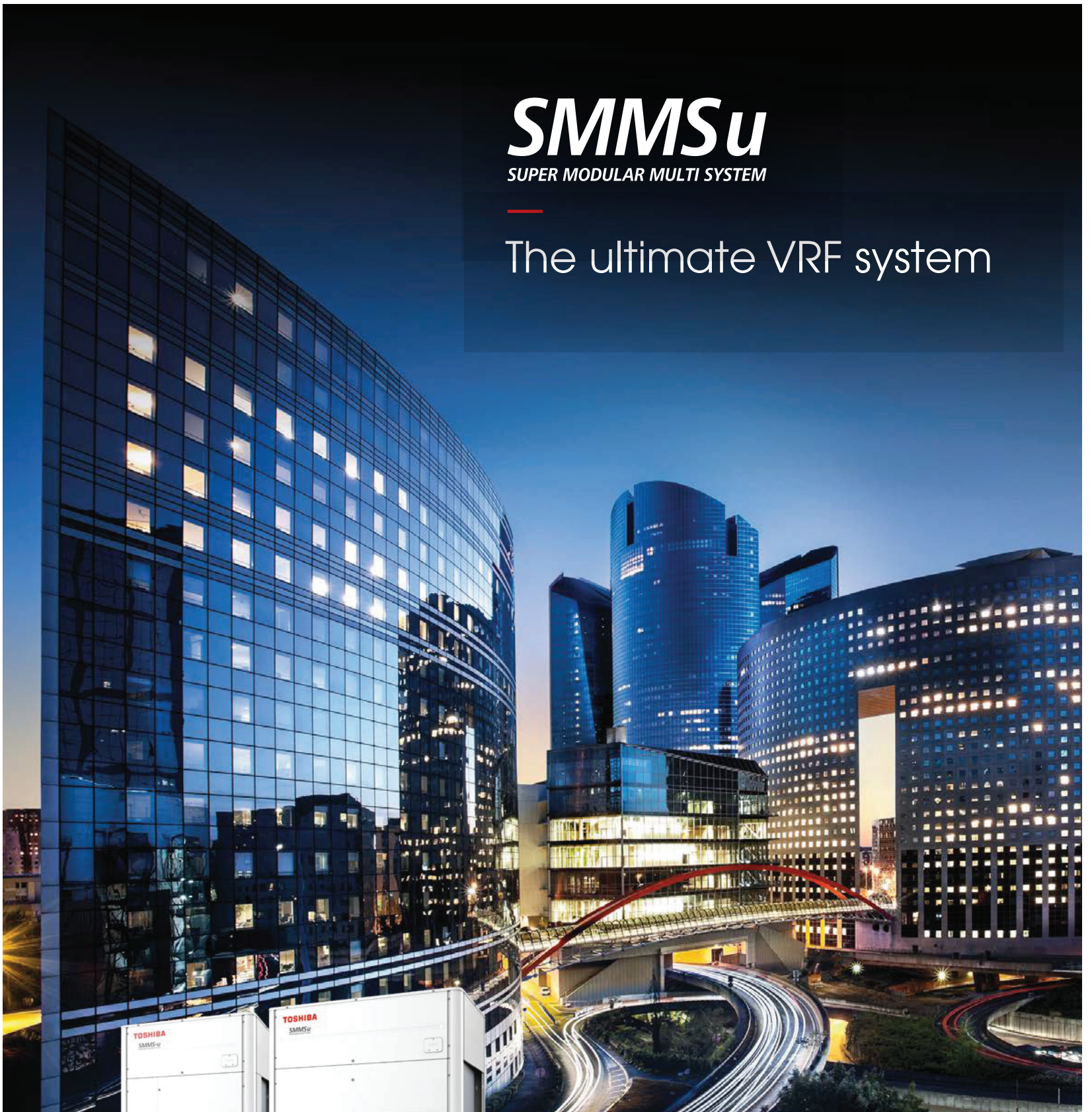

 *Better Air Solutions*

EXPERIENCE THE FUTURE

The expectations of a modern air conditioning system have evolved over the past years. Today, advanced comfort goes hand in hand with reduced energy and maintenance costs, combined with maximized simplicity and true operational flexibility. SMMS-u associates all of Toshiba innovative spirit and outstanding expertise to create highly efficient solution with maximum end user comfort at its core.

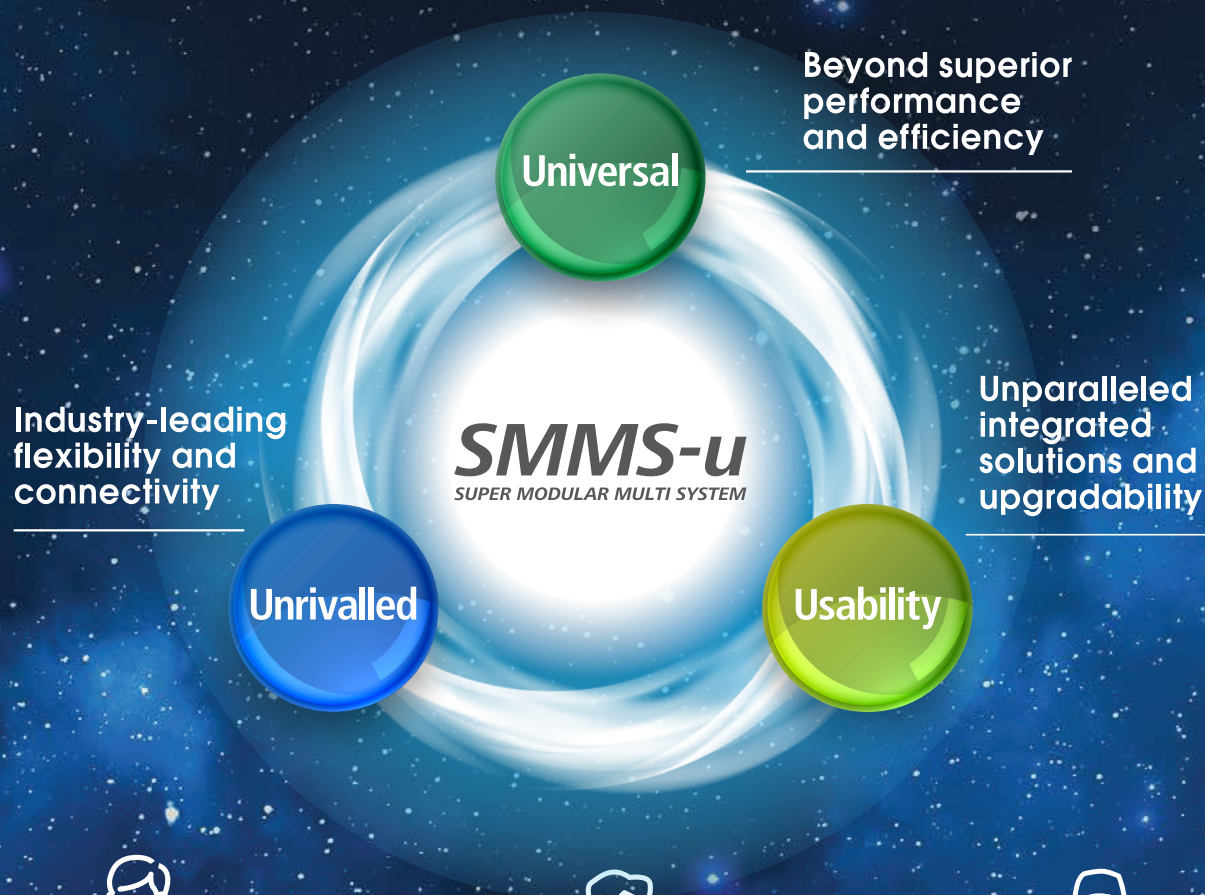

Benefits for consultants

SMMS-u offers unlimited possibilities in terms of capacity, connectivity, indoor unit lineup and control solutions, providing the correct solution for your customers needs. Toshiba's intuitive selection tool will guide you through the selection process with minimal input from your side, ensuring trouble-free installation and operation.

All SMMS-u systems come with the Eurovent certification as standard.



Benefits for users

There is nothing like a comfortable place to enjoy the present moment. Full of Toshiba innovations, the new SMMS-u guarantees all year round comfort combined with superior energy management, advanced air filtration and full control solutions for maximized product usability.



Benefits for installers

Designed to perform and engineered to perfection, SMMS-u excels in managing the heating, cooling, hot water and fresh air input into offices, shops, restaurants and domestic housing, with unrivalled connection flexibility. You can rely on Toshiba support, to assist you from the project phase to commissioning and troubleshooting.

A BRAND NEW CHASSIS

Discover a totally new redesigned chassis which is now the perfect mix between dimension, efficiency, capacity & sound level. Engineered in Japan, SMMS-u integrates all the latest technological innovations from Toshiba to achieve top class efficiency and ensure unrivalled comfort levels.

Up to 24HP single module / 120HP combination

Simplified maintenance: Easy access to main components

Earthquake and typhoon resistant chassis



Strong air flow: up to 80Pa available pressure

Compact chassis: only 1.690mm height

Super-efficient: full product height heat exchanger

UNIQUE ON THE MARKET: TRIPLE ROTARY COMPRESSOR

The exclusive Toshiba triple rotary compressor brings outstanding performances to the SMMS-u with no compromise on system reliability.



 Large capacity

 Wide operating range

 Less refrigerant needed

 Low vibration

 Low noise

 DLC treatment

TOP CLASS EFFICIENCY



Utilizing the new highly efficient core technologies results in greater energy efficiency and performances.

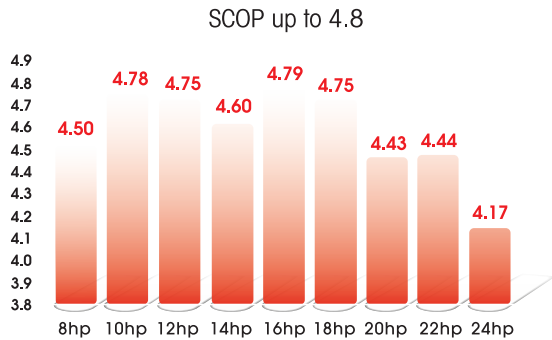
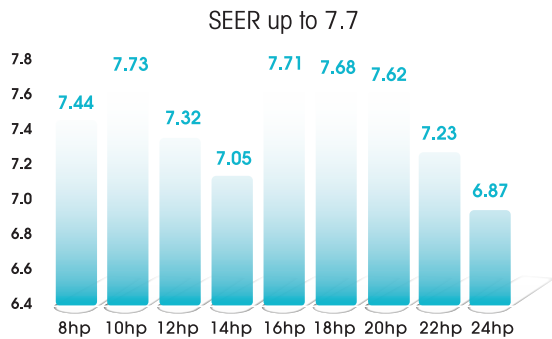

STRONG CONNECTIVITY

SMMS-u oversteps all the limits of VRF for maximized project coverage. Whatever the piping length, the height difference, the number of indoor units connected and operating... SMMS-u is always delivering the best.

2,000 combinations patterns
to achieve up to 120HP

1,200m max
piping length

110m max
piping height

Heating, cooling, fresh air
and hot water production

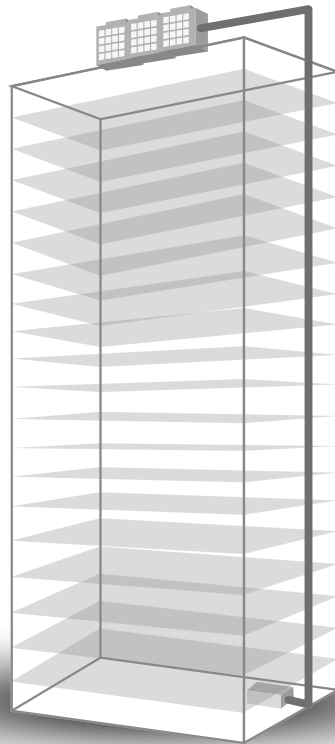

Up to 128 indoor
units connected

-25°C heating
+52°C cooling

Max 200%
diversity ratio

STRONG ADAPTABILITY

SMMS-u integrates new features to adapt operations to local constraints with a constant target: the alliance of comfort and energy savings.



Split heat
exchanger

Heat Exchanger automatically varies depending on workload, maximizing energy savings and system reliability.



Demand
control

Smart Grid ready with remote or dry contact demand control function.



Autobackup
function

Automatic backup in case of combinations systems failure.



Rotation
drive

Smart control to automatically equalize compressor operating hours.



Balance oil
circuit free

No oil balance pipe needed with the new lubrication technology.

COMFORT ABOVE ALL

Providing end user high level of comfort is the SMMS-u priority. In addition to a wide range of indoor units adapted to any kind of room configuration, defrost logic has also evolved to increase continuous run time, shorten defrost cycles. Toshiba is offering one of the most accurate refrigerant flow management system.

INTELLIGENT DEFROST

Individual defrost : continuous heating up to 5 hours.



KO-BE-TSU

No simultaneous defrost in combination configuration. Heating operation never stopped.

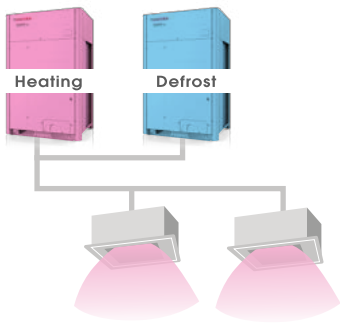

Renkey

No simultaneous defrost with multi system configuration. Heating operation never stopped.

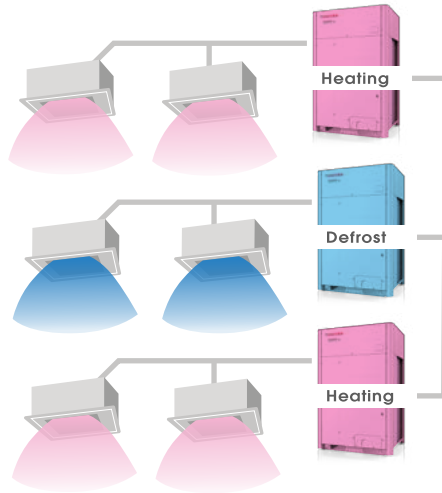

INTELLIGENT VRF CONTROL

Mixing 0.1Hz compressor speed control with high precision pulse motor valve, SMMS-u is delivering the right quantity of refrigerant to all indoor units in demand. No extra quantity of refrigerant is compressed, only the good one. Result is a power consumption directly link to the user demand no more, no less.

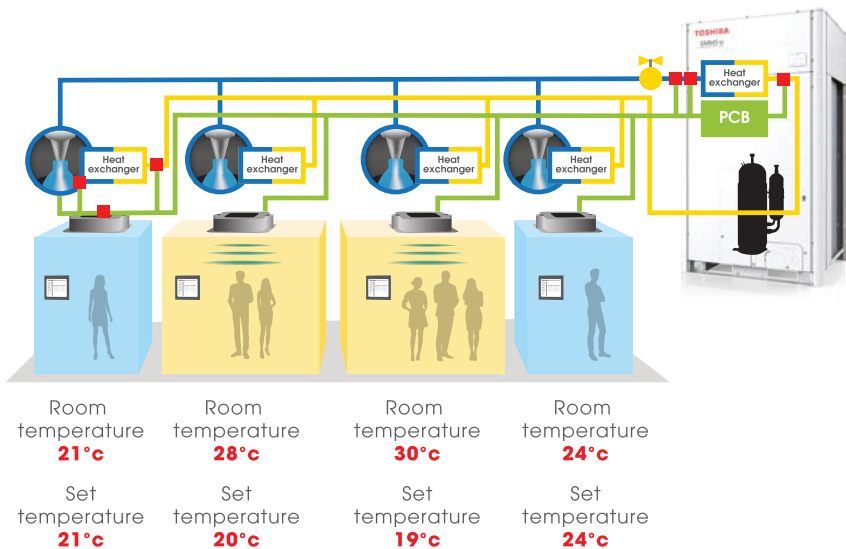

WIDEST INDOOR UNIT RANGE

16 different indoor unit types. 17 capacities from 0.3 to 14HP. Thousands of combinations to perfectly match users expectations.

2021 NEW
indoor units



Smart cassette
High performance
Smart operation



1-Way cassette
0.3HP capacity
Compact chassis
Smart operation
Advanced filtration

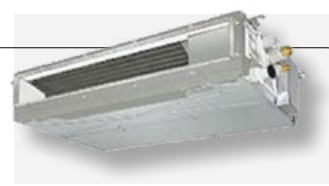

Slim duct
0.3HP capacity
Compact chassis
Quiet operation

SMMS-u Indoor units

Model	(HP)	0.3	0.6	0.8	1	1.25	1.7	2	2.5	3	3.2	4	5	6	8	10	12	14
	(kW)	1,9	1,7	2,2	2,8	3,6	4,5	5,6	7,1	8	9	11,2	14	16	22,4	28	34	40
CASSETTE TYPES																		
High performance 4-way Cassette MMU-UP_1H-E/TR																		
4-way Cassette MMU-UP_1HP-E/TR																		
Compact 4-way Cassette MMU-UP_1MH-E/TR																		
2-way Cassette MMU-UP_1WH-E/TR																		
1-way Cassette MMU-UP_1YH-E/TR																		
1-way Cassette MMU-UP_1SH-E/TR																		
DUCT TYPES																		
Slim Duct MMD-UP_SPHY-E/TR																		
Concealed Duct MMD-UP_BHP-E/TR																		
HSP Concealed Duct MMD-UP_HP-E/TR																		
Fresh Air Intake Duct MMD-UP_1HFP-E/TR																		
CEILING TYPES																		
Ceiling MMC-UP_HP-E/TR																		
HIGH WALL TYPES																		
High Wall (with PMV) MMK-UP_HP-E/TR																		
High Wall (without PMV) MMK-UP_HPL-E/TR																		
FLOOR STANDING TYPES																		
Console MML-UP_1NH-E/TR																		
Floor Standing Cabinet MML-UP_1H-E/TR																		
Floor Standing Concealed MML-UP_1BH-E/TR																		
Floor Standing MMF-UP_1H-E/TR																		
WATER PRODUCTION																		
Mid Temperature Water Module MMW-UP_1LQ-E/TR																		

● New

WIDE CONTROL LINEUP

Wireless, simplified, advanced, individual, centralized, connected, with touch screen... Toshiba is offering a large choice of control solutions all compatible with the new TU2C Link protocol. SMMS-u is also compatible with Bacnet®, Lonworks® and Modbus® BMS languages

BMS-CT256U-E
Max 256 indoor units connected



RBC-AMS51U-ES/EN
Max 16 indoor units connected



RBC-ASC11U-E
Max 16 indoor units connected

EASY COMMISSIONING AND MAINTENANCE

Save time during commissioning and maintenance. Choose between the "Wave Tool Advance" using Smartphone NFC connection or the link adaptor connected to the outdoor or indoor unit.



TOSHIBA SELECTION TOOL



Designed for novice and expert users, Toshiba selection software creates simple, yet detailed VRF system schematics. It is highly versatile, allowing the level of detail to be tailored to suit customer requirements. Final detailed reports can be produced and sent to customers in PDF format or in more complex files, such as AutoCAD DXF, allowing simple integration into existing software packages.

TOSHIBA

SMMS-u Performances

Outdoor unit		MMY-	MUP0801HT8P-E/TR	MUP1001HT8P-E/TR	MUP1201HT8P-E/TR	MUP1401HT8P-E/TR	MUP1601HT8P-E/TR	MUP1801HT8P-E/TR	MUP2001HT8P-E/TR	MUP2201HT8P-E/TR	MUP2401HT8P-E/TR
			8 HP	10 HP	12 HP	14 HP	16 HP	18 HP	20 HP	22 HP	24HP
Cooling capacity	kW		22.4	28.0	33.5	40.0	45.0	50.4	56.0	61.5	67.0
Power input	kW C		5.64	8.36	10.34	14.55	14.06	15.90	18.01	20.43	24.19
EER	W/W		3.97	3.35	3.24	2.75	3.20	3.17	3.11	3.01	2.77
SEER	η/std		294.6%/7.44	306.2%/7.73	289.8%/7.32	279.0%/7.05	305.4%/7.71	304.2%/7.68	301.8%/7.62	286.9%/7.23	271.8%/6.87
Running current	A C		9.1	13.4	16.0	22.6	21.6	24.4	27.7	31.4	37.1
Heating capacity rated/max	kW		22.4/25.0	28.0/31.5	33.5/37.5	40.0/45.0	45.0/50.0	50.4/56.0	56.0/63.0	61.5/69.0	67.0/70.0
Power input (rated)	kW H		5.28	7.20	7.77	10.00	11.94	12.54	14.93	16.18	18.98
COP (rated)	W/W		4.24	3.89	4.31	4.00	3.77	4.02	3.75	3.80	3.53
SCOP	η/std		177.0%/4.50	188.2%/4.78	187.0%/4.75	181.0%/4.6	188.6%/4.79	187.0%/4.75	174.2%/4.43	174.6%/4.44	163.8%/4.17
Running current	A H		8.56	11.5	12.1	15.5	18.3	19.3	22.9	24.8	29.1
Maximum overcurrent protection	A		20	32	32	40	40	50	50	63	80

SMMS-u Physical data

Outdoor unit		MMY-	MUP0801HT8P-E/TR	MUP1001HT8P-E/TR	MUP1201HT8P-E/TR	MUP1401HT8P-E/TR	MUP1601HT8P-E/TR	MUP1801HT8P-E/TR	MUP2001HT8P-E/TR	MUP2201HT8P-E/TR	MUP2401HT8P-E/TR
			9900	10500	11700	11880	15300	16800	15900	16500	16500
Sound Power Level	dB(A) C		75.0	77.0	79.0	79.0	83.0	84.0	86.0	86.0	86.0
Sound pressure level	dB(A) C		53.0	55.0	58.0	58.0	60.0	61.0	63.0	63.0	63.0
Sound Power Level	dB(A) H		76.0	77.0	81.0	82.0	86.0	89.0	90.0	90.0	90.0
Sound pressure level	dB(A) H		56.0	58.0	62.0	62.0	63.0	67.0	67.0	67.0	67.0
External Static pressure available	Pa		80	80	80	80	80	80	80	80	80
Dimensions (h x w x d)	mm		1690 x 990 x 780	1690 x 990 x 780	1690 x 990 x 780	1690 x 990 x 780	1690 x 1290 x 780	1690 x 1290 x 780	1690 x 1290 x 780	1690 x 1290 x 780	1690 x 1290 x 780
Weight	kg		228	228	228	228	312	312	334	356	356
Compressor type			Hermetic Twin Rotary	Hermetic Twin Rotary	Hermetic Twin Rotary	Hermetic Twin Rotary	Hermetic Triple Rotary	Hermetic Triple Rotary	Hermetic Triple Rotary	Hermetic Twin Rotary	Hermetic Twin Rotary
Refrigerant charge R410A	kg		6.0	6.0	6.0	6.0	9.0	9.0	9.0	9.0	9.0
	TCO _{2eq}		12.53	12.53	12.53	12.53	18.79	18.79	18.79	18.79	18.79
Gas line type - diameter			Brazed - 3/4"	Brazed - 3/4"	Brazed - 1-1/8"	Brazed - 1-1/8"	Brazed - 1-1/8"	Brazed - 1-1/8"	Brazed - 1-1/8"	Brazed - 1-1/8"	Brazed - 1-3/8"
Liquid line type - diameter			Brazed - 1/2"	Brazed - 1/2"	Brazed - 1/2"	Brazed - 5/8"	Brazed - 5/8"	Brazed - 5/8"	Brazed - 5/8"	Brazed - 3/4"	Brazed - 3/4"
Farthest piping equivalent length	m		250	250	250	250	250	250	250	250	250
Farthest piping real length	m		210	210	210	210	210	210	210	210	210
Maximum pipe length	m		500	500	500	500	500	500	500	500	500
Maximum lift (indoor unit above/below)	m		110/110	110/110	110/110	110/110	110/110	110/110	110/110	110/110	110/110
Operating range - db	°C C		-10/52	-10/52	-10/52	-10/52	-10/52	-10/52	-10/52	-10/52	-10/52
Operating range - wb	°C H		-25/15.5	-25/15.5	-25/15.5	-25/15.5	-25/15.5	-25/15.5	-25/15.5	-25/15.5	-25/15.5
Power supply	V-ph-Hz		380/415-3-50	380/415-3-50	380/415-3-50	380/415-3-50	380/415-3-50	380/415-3-50	380/415-3-50	380/415-3-50	380/415-3-50

C: cooling mode - H: heating mode



AHI CARRIER SEE

GREECE

AHI CARRIER S.E. EUROPE SINGLE MEMBER S.A.

Headquarters

18, Kifissou Ave.
104 42 - Athens
Tel.: +30 210 6796300

Thessaloniki Branch

5, Ag. Georgiyo str., Cosmos Offices
570 01 - Patriarhiko Pileas Thessaloniki
Tel.: +30 231 3080430

grinfo@ahi-carrier.eu

www.toshiba-aircon.gr

Authorized by Carrier Corporation
as a distributor of Toshiba HVAC products for SEE.

BULGARIA

AHI CARRIER HVAC BULGARIA EOOD

Trade Center Europe Building 6,floor 3, office 6
7 Iskarsko Shose Blvd., Sofia 1528
Tel.: +35 929483960
bginfo@ahi-carrier.com
www.toshiba-aircon.bg

ROMANIA

AHI CARRIER ROMANIA SRL

Intrarea Nestorei 1, Corp B, Et. 5, Sector 4
Cladirea River Plaza, RO-040295 Bucuresti
Tel.: +40 214 050751
roinfo@ahi-carrier.eu
www.toshiba-aircon.ro



TOSHIBA Air Conditioning participates in the ECP program for Carrier Air Conditioners (A/C). Check ongoing validity of certificate: www.eurovent-certification.com

